

Table of contents

1.	Introduction	1
2.	Purpose of document	1
3.	Climate data	2
4.	Hydrologic routing	4
5.	Source nodes	5
6.	General guidelines for treatment nodes	11
7.	Swales	13
8.	Gross pollutant traps (GPTs)	14
9.	Sediment ponds (labelled "sedimentation basin" in MUSIC)	14
10.	Wetlands	16
11.	Ponds	19
12.	Bioretention systems (raingardens, biofilters)	19
13.	Permeable pavement	20
14.	Imported data nodes	21
15.	Generic treatment nodes	21
16.	Use of secondary links	21
17.	Exporting results	22
18.	Submission requirements for MUSIC modelling	25

Disclaimer: This document may be of assistance to you but Melbourne Water and its employees do not guarantee that the publication is without flaw of any kind or is wholly appropriate for your particular purposes and therefore disclaims all liability for any error, loss or other consequence which may arise from you relying on any information in this document.

1. Introduction

MUSIC is software that simulates rainfall, stormwater runoff and pollution. It also simulates pollution removal and flow reduction through stormwater management systems such as sediment ponds, wetlands, bioretention and harvesting.

Stormwater management minimum requirements are set by the Victorian Environmental Protection Agency (EPA) through the Best Practice Environmental Management Guidelines (BPEMG). The latest BPEMG information is available via the EPA Victoria website:

<http://www.epa.vic.gov.au/business-and-industry/guidelines/water-guidance/urban-stormwater-bpemg>

Melbourne Water, Councils the EPA and other authorities may require different stormwater management levels depending on the receiving environment.

The design intent for any treatment system must be clearly documented and discussed with Melbourne Water early in the conceptual design stage. Melbourne Water uses MUSIC to assess the impacts of proposed development against performance targets. If methods or models other than MUSIC are used (for example EPA SWMM), the designer must demonstrate to Melbourne Water's satisfaction that performance targets can be achieved.

2. Purpose of document

This document provides guidance on modelling approaches and input parameters for MUSIC models that are submitted to Melbourne Water. The MUSIC User Manual is also useful for building a model.

The objectives are to:

- Ensure a consistent, fair and evidence based approach is applied to MUSIC models.
- Be specific to the climate and geology of the Melbourne region
- Reduce the time taken by Melbourne Water in assessing models.

Users are expected to have an understanding of water sensitive urban design principles and approaches and have knowledge and training in the use of the MUSIC software.

This document is a modelling guideline, and should be read in conjunction with appropriate design guidelines such as:

- WSUD Engineering Procedures: Stormwater (Melbourne Water, 2005) and
- [Melbourne Water Constructed Wetlands Design Manual](#) (Melbourne Water, 2014)

MUSIC can help validate pollutant removal for a design, but is not the only validation. MUSIC is not suitable for validating drainage design. Other requirements are outlined in the above documents. Other referral authorities, including Local Government, may have their own requirements for MUSIC modelling.

3. Climate data

Rainfall template

Melbourne Water provides MUSIC [rainfall templates](#) for 10 year periods that can be downloaded from our website. All models submitted to Melbourne Water must use Melbourne Water’s rainfall templates unless written permission is provided by Melbourne Water.

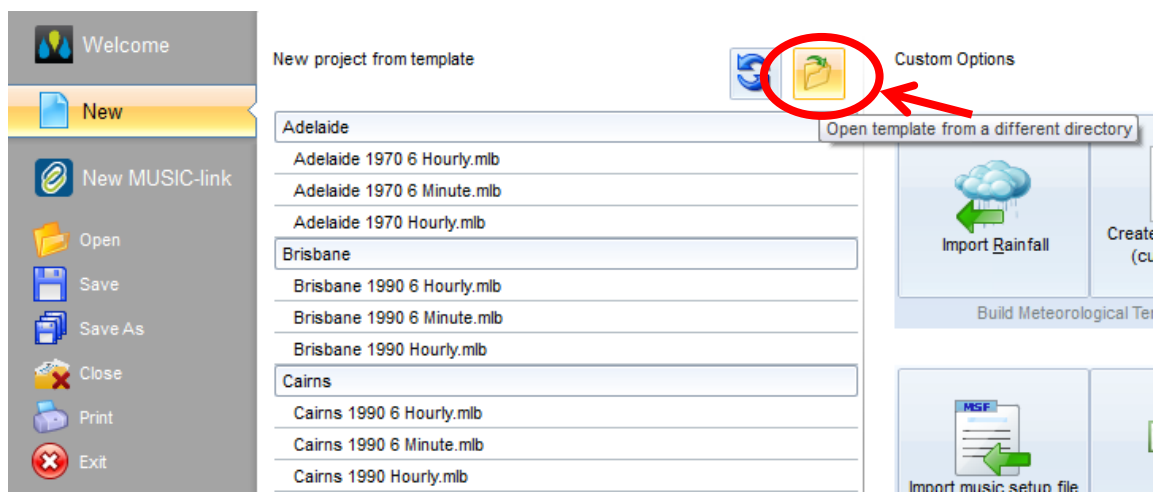

Figure 1 - Step to select a Melbourne Water provided 10 year period rainfall template

The rainfall distribution map below can be used to find the appropriate rainfall template or weather station for a site; [a JPEG large-scale version of the map](#), ESRI and MapInfo layers and the rainfall templates are available on the [Melbourne Water guidelines webpage](#).

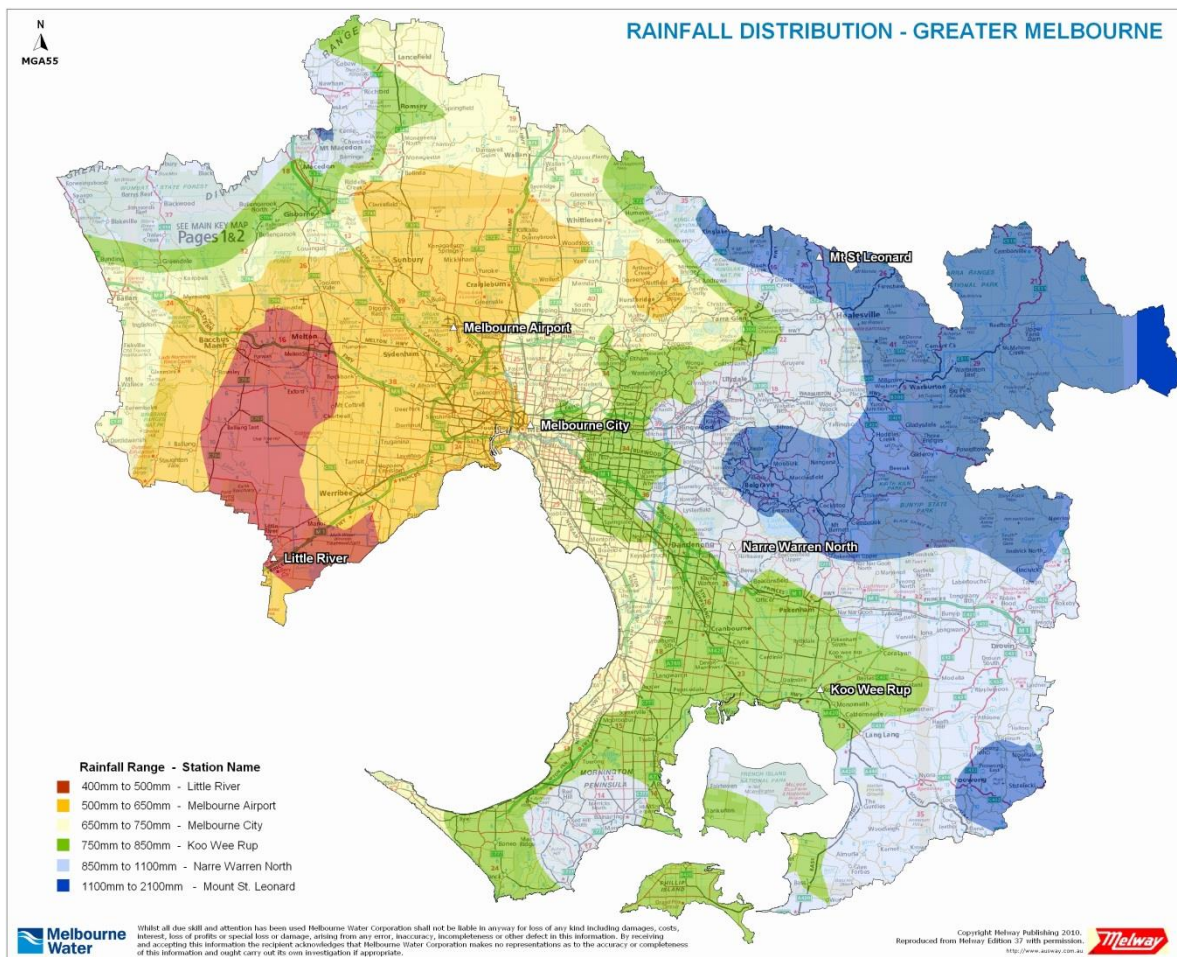

Figure 2. Rainfall template selection map

Climate data including rainfall and evapotranspiration are essential inputs to MUSIC. MUSIC is a continuous simulation model and requires an input time series of rainfall data. If you intend to model without Melbourne Water provided rainfall templates, data is available from the Bureau of Meteorology at a 6 minute timestep for a number of gauges across Melbourne Water’s service area.

The selection of a rainfall gauge and period should consider:

- local rainfall patterns for the site of interest
- completeness of record
- representation of a range of conditions including wet and dry periods and a variety of storm events of varying size and antecedent dry periods
- purpose of the model

The choice of meteorological data is a balance between the level of accuracy required and the time and effort required for modelling. The templates Melbourne Water provides represent the rainfall variations across metropolitan Melbourne.

The following periods are recommended:

- **10 year period:** A minimum period of 10 years for:
 - all Development Services / Drainage Scheme designs
 - modelling of areas including significant areas of pre-development, rural or pervious land.
 - Analysis of flow frequency objectives such as number of flow days, stream erosion index and flow frequency curves
- **20+ year period:** Municipal and larger integrated water management strategies, waterway flow analyses, analysis of large pervious catchments (> 100 ha).

Timestep

All models must be run at a 6 minute timestep where this is possible. The use of longer timesteps can result in significant errors and increase the variability of the results. Where a different timestep is adopted, it must comply with the following:

The timestep must be equal to or less than:

1. the Time of Concentration of the smallest Sub-Catchment, and
2. the shortest detention time (under design flows) of the treatment measures being modelled.

Circumstances where a different modelling timestep may be appropriate include:

1. concept level modelling of systems that have long times of concentration and detention times, such as rivers or lakes, where no representative 6 minute data is available
2. where a larger timestep is required to interface with another model and allow consistent rainfall to be used. Depending on the outputs required, it may be possible to run MUSIC at a 6 minute time step and export results at a longer time step.

4. Hydrologic routing

Hydrologic routing should be used where appropriate to reflect the Time of Concentration of the Catchment as calculated using a recognised procedure. Routing can be ignored to reduce the complexity of the model. Not using routing can result in the performance of treatment systems being underestimated. If routing is used, it should be applied consistently across a model; otherwise timing of peak flows (and possible coincident peaks) will not be modelled correctly.

5. Source nodes

Source node selection (urban, forest, agricultural etc)

Urban ("Mixed" Zoning/Surface Type) nodes are recommended for most modelling purposes to represent existing urban, new development and parkland areas. Forest nodes are only recommended for use when representing old growth or well established forested areas. The agricultural node has elevated nutrient concentrations and can be used to represent actively farmed areas.

Source nodes can be split by surface type (e.g. roads, roofs). Input parameters for stormwater pollutant concentrations (other than default values) are listed in Table 3 on page 9. Other parameters may be accepted if there is suitable published data to support this - subject to prior agreement by Melbourne Water.

Impervious fraction

The following table can be used to estimate the fraction effective impervious for different land uses. Any significant deviation from the figures in the table below must be supported by relevant information (i.e. long term flow data that enables calibration of the model).

The "effective impervious" percentage (portion of impervious area that drains via a constructed drainage system) must be used.

Zone	Zone Code	Brief Description / Examples	Normal Range	Typical Value
Residential Zones:				
Residential Growth Zone, General Residential Zone and Neighbourhood Residential Zone	RGZ, GRZ & NRZ	Large Residential. (Allotment size 601m ² – 1000m ²)	0.50 – 0.80	0.60
		Standard densities. (Allotment size 300m ² – 600m ²)	0.70 – 0.80	0.75
		High densities. (Allotment size <300m ²)	0.80 – 0.95	0.85
Low Density Residential Zone	LDRZ	Allotment size >1001m ²	0.10 – 0.30	0.20
Mixed Use Zone	MUZ	Mix of residential, commercial, industrial and hospitals.	0.6 – 0.90	0.75
Township Zone	TZ	Small townships with no specific zoning structures	0.40 – 0.70	0.55
Industrial Zones				
Industrial 1 Zone	IN1Z	Main zone to be applied in most industrial areas	0.70 – 0.95	0.90
Industrial 2 Zone	IN2Z	Large industrial zones away from residential areas	0.70 – 0.95	0.90
Industrial 3 Zone	IN3Z	Buffer between Zone 1 and Zone 3	0.70 – 0.95	0.90
		- for garden suppliers/nurseries	0.30 – 0.60	0.50
		- for quarries	0.10 – 0.30	0.20
Commercial Zones				
Commercial 1 Zone	C1Z	Main zone to be applied in most commercial areas	0.70 – 0.95	0.90
Commercial 2 Zone	C2Z	Offices, manufacturing industries and associated uses	0.70 – 0.95	0.90
Rural Zones				
Rural Zone	RUZ	Main zone to be applied in most rural areas	0.05 – 0.20	0.10
Rural Living Zone	RLZ	Predominantly residential use in rural areas	0.10 – 0.30	0.20
Public Land Zones:				
Public Use Zone				
- Education	PU2Z	- schools and universities	0.60 – 0.80	0.70

Zone	Zone Code	Brief Description / Examples	Normal Range	Typical Value
- Service and Utility	PU1Z	power lines, pipe tracks and retarding basins	0.00 – 0.10	0.05
		- reservoirs	0.40 – 0.60	0.50
- Health and community	PU3Z	- hospitals	0.80 – 0.90	0.85
- Transport	PU4Z	- railways and tramways	0.60 – 0.80	0.70
- Cemetery/ Crematorium	PU5Z	- cemeteries and crematoriums	0.50 – 0.70	0.60
Local Government	PU6Z	- Libraries, sports complexes and offices/depots.	0.50 – 0.90	0.70
- Other Public Use	PU7Z	- Museums	0.50 – 0.80	0.60
Public Park and Recreation Zone	PPRZ	Main zone for public open space, incl golf courses.	0.00 – 0.20	0.10
Public Conservation and Resource Zone	PCRZ	Protection of natural environment or resources	0.00 – 0.05	0.00
Road Zone – Category 1	RDZ1	Major roads and freeways	0.60 – 0.90	0.70
Road Zone – Category 2	RDZ2	Secondary and local roads	0.50 – 0.80	0.60
Special Purpose Zones				
Special Use Zone	SUZn	Development for specific purposes	0.50 – 0.80	0.60
Comprehensive Development Zone	CDZn	Large and complex developments – residential	0.40 – 0.80	0.50
Urban Floodway Zone	UFZ	Land identified as part of an active floodway	0.00 – 0.05	0.00
Capital City Zone	CCZn	Special use Zone for land in Melbourne’s central city	0.70 – 0.90	0.80
Docklands Zone	DZn	Special use Zone for land in Docklands area	0.70 – 0.90	0.80
Commonwealth Land	CA	Army Barracks, CSIRO	0.50 – 0.80	0.60

Table 1 - Effective Impervious values for source nodes

Note: Values included in this table are not runoff coefficients and should not be used as runoff coefficients for flood modelling.

If the catchment is already fully developed, the effective imperviousness fraction can be calibrated using local rainfall and stream flow data. In many cases the catchment is yet to be developed, so rainfall and stream flow data is not useful.

The preferred method for developed catchments smaller than around 10 hectares, where accurate details of the drainage system is known, is to estimate the proportion of impervious surfaces that are effectively connected to the drainage system. An example estimate of effective imperviousness for a small catchment is provided below:

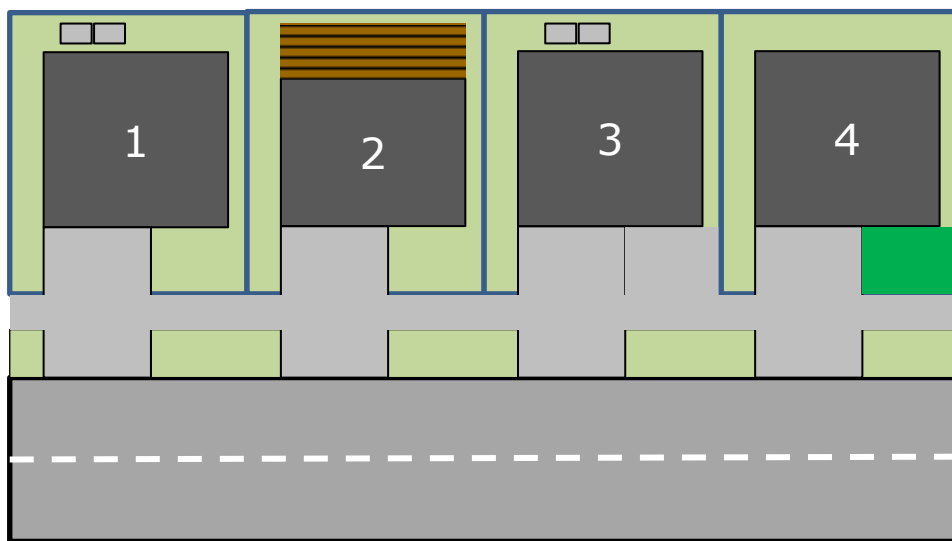

Figure 3- Impervious fraction calculation example

Property 1 has a 15m^2 paved area in the backyard that drains to an equivalent area of surrounding grass, not directly connected to the drainage system.

Property 2 has an uncovered wooden deck in the back yard that allows rainwater to fall through to the ground below. This deck is not counted as an impervious surface.

Property 3 has additional paved area in the front yard connected to the drainage system and a 15m^2 paved area in the backyard that drains to an equivalent area of surrounding grass, not directly connected to the drainage system.

Property 4 has synthetic grass in the front yard that connects to the drainage system.

Total Area	3000 m ²
Impervious Area Directly Connected	
All Roofs	744 m ²
Road	933 m ²
Driveways	387 m ²
Footpath	104 m ²
House 4 synthetic turf	38 m ²
House 3 additional front yard paving	38 m ²
Impervious Area Not Directly Connected	
House 1 & 3 backyard paving	30 m ²
Total Impervious Fraction = (744+933+387+104+38+38+30)/3000	76%
Effective Impervious Fraction (to be used in MUSIC) = (744+933+387+104+38+38)/3000	75%

Table 2 - Effective Impervious calculation example

Note – All impervious areas that drain to WSUD features, such as the raingarden and rainwater tank in this example, must be counted in the effective impervious fraction.

Soil parameters

In MUSIC the pervious area properties default to Brisbane properties. These will need to be altered to reflect Melbourne properties. Any deviation from the Melbourne parameters listed here should be described in the report provided with the model. Supporting evidence should also be provided.

The soil input parameters recommended here are based on a review of twelve catchment calibrations undertaken for Melbourne catchments in recent years.

Soil Store Capacity = 120mm

Field Capacity = 50mm

Pollutant concentration data

The default values provided for TSS, TP and TN must be used unless written permission is given by Melbourne Water. In models where roofs, paved areas and the remaining vegetated areas of urban areas are split into separate source nodes, the following guideline values will be accepted:

Pollutant	Surface Type	Storm Flow		Base Flow	
		Mean (log mg/L)	SD (log mg/L)	Mean (log mg/L)	SD (log mg/L)
SS	Roof	1.301	0.333	n/a*	n/a
	Road and paved areas	2.431	0.333	n/a	n/a
	Urban area not covered by roof, road or paved areas	1.900	0.333	0.96	0.401
TP	Roof	-0.886	0.242	n/a	n/a
	Road and paved areas	-0.301	0.242	n/a	n/a
	Urban area not covered by roof, road or paved areas	-0.700	0.242	-0.731	0.360
TN	Roof	0.301	0.205	n/a	n/a
	Road and paved areas	0.342	0.205	n/a	n/a
	Urban area not covered by roof, road or paved areas	0.243	0.182	0.455	0.363

Table 3 - Pollutant concentration data for source nodes. * n/a indicates that base flow does not occur from these surfaces. (Source: Fletcher, 2007. Background Study for the revision of Melbourne Water's MUSIC Input Parameter Guidelines. Not published)

Serial correlation

The Serial Correlation (R squared) must be zero for TSS, TP and TN for analysis of stormwater quality.

Stochastic versus mean generated data

Stochastically generated data must always be used, except where there is a requirement to examine behaviour for a particular storm event or set of operating conditions.

6. General guidelines for treatment nodes

K, C*, C**

Melbourne Water must approve any changes to these parameters in writing. Any data used to modify these parameters must be published data, and be appropriate for the circumstances being modelled.

Plant survival

MUSIC cannot model plant death due to long dry periods or excessive water depth. Other analysis is needed to make sure the plants selected will contribute to pollutant removal over the life of the treatment node if non-standard designs are used. The wetland analysis tool on the <http://musicauditor.com.au/> website can provide evidence that plant survival is possible.

Number of CSTR cells

The CSTR input parameter in MUSIC represents the mixing behaviour of treatment nodes. The default number of CSTR cells for a treatment node can be changed through the "More" button. The number of CSTR cells for sedimentation basins can also be changed through the "Estimate Parameters" button.

The length to width ratios for the shapes used to estimate the number of CSTR cells is listed in the figure below.

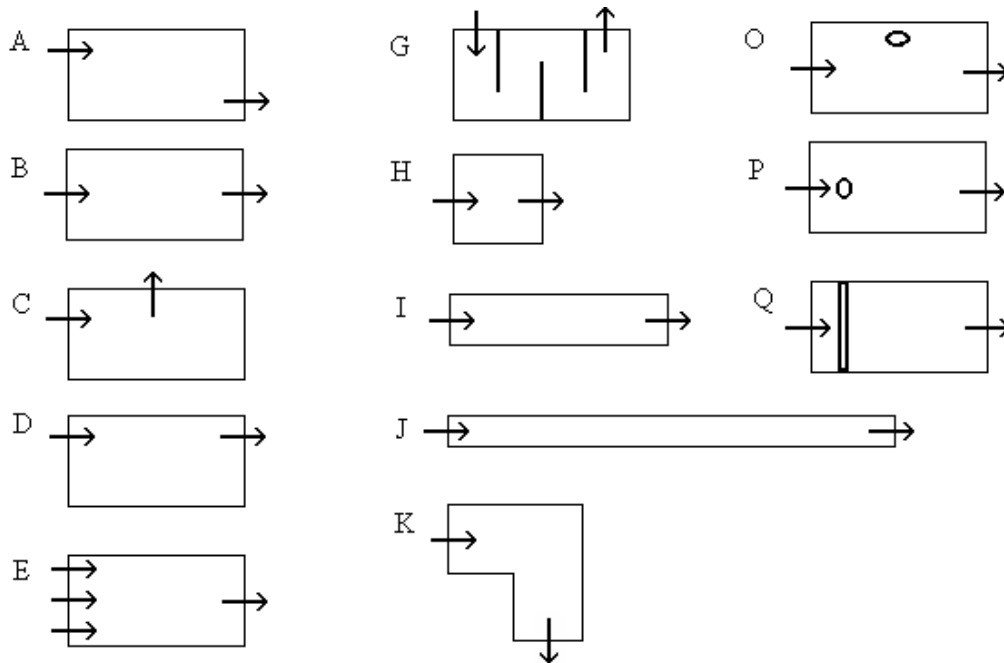

Figure 4 - Treatment node shape to determine the number of CSTR cells (Persson, 2000). **Length to width ratio: A, B, C, D, E, G, O, P, Q - 2:1; H - 1:1; I - 4:1; J - 12:1; K - 3:1; P contains an island blocking the central flow path and Q contains a structure to distribute the flows evenly.**

Treatment trains

Treatment nodes within a MUSIC model must be linked in an appropriate order, with primary treatment devices first and tertiary treatment devices last (if present).

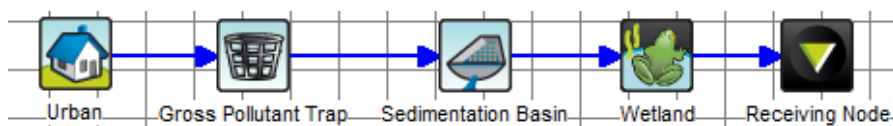

Figure 4 - example treatment train

Exfiltration

The exfiltration rate relates to the seepage rate (in mm/hr) of the soil surrounding and underlying a treatment system and is used to represent losses from a treatment system into the surrounding soils. Exfiltration does not refer to the hydraulic conductivity of the soils contained within the treatment system.

For all nodes, adoption of an exfiltration rate greater than 0 mm/hr must be supported by geotechnical information, and, for Melbourne Water assets, prior agreement by Melbourne Water is needed. Exfiltration is encouraged where practical.

Instream works and waterways

Do not include constructed or natural waterways, or grassed retarding basins as treatment nodes.

Stormwater harvesting (labelled "reuse" in MUSIC)

Details on Melbourne Water's processes for stormwater harvesting can be found here:

<http://www.melbournewater.com.au/planning-and-building/stormwater-management/stormwater-harvesting/pages/stormwater-harvesting-licence.aspx>

For large scale stormwater harvesting, a reuse master plan must be provided which is to be signed off by all relevant authorities (Local Government, Retail Water Company, Melbourne Water). Calculations should be provided to support volumes of harvested stormwater. All harvested stormwater should be treated to a fit-for-purpose standard that also supports the long term sustainability of the reuse infrastructure (including irrigation infrastructure).

Guidelines on quality of harvested stormwater and treatment for public health can be found online by searching for "Australian Guidelines for Water Recycling: Managing Health and Environmental Risks (Phase 2) Stormwater Harvesting and Reuse".

Stormwater harvesting can contribute to treatment train performance if the demands are reliable (e.g. toilet flushing – 20 litres per person per day; laundry – 80 litres per household per day). Irrigation of residential blocks is encouraged; however this is not a reliable demand. On site treatment claims on the Stormwater Quality Offset Contribution Form cannot include residential irrigation.

For stormwater harvesting to be accepted as part of a MUSIC model, there needs to be a suitable agreement between the relevant stakeholders.

A minimum of ten years of six minute rainfall data must be used to model all stages of a design that includes stormwater harvesting.

7. Swales

Suggested vegetation heights:

- **Grass swale** (mowed) height range: 10 – 100mm
- **Vegetation** (not mowed): 100 – 400mm

In the case where unmown vegetation is being used, the proponent should identify what type of vegetation is proposed, and how it will be managed within the landscape and maintenance requirements of the development. Waterways within developments cannot be deemed as swales and shall not be included in the treatment train model.

8. Gross pollutant traps (GPTs)

No treatment can be attributed to a GPT unless it is supported by reliable studies. Where reliable and locally representative data is available, gross pollutant and sediment treatment may be attributed to a GPT.

9. Sediment ponds (labelled "sedimentation basin" in MUSIC)

Use of separate 'sedimentation pond' and 'wetland' nodes

If the sediment pond outlet flow is influenced by the water level in the wetland macrophyte zone, a single "wetland" node should be used to represent the system in MUSIC without a "sedimentation basin" node. The sediment pond should be represented by input parameters of the Inlet Pond Volume of the wetland node.

If the sediment pond outlet flow is not influenced by the water level in the wetland macrophyte zone, the sediment pond and wetland macrophyte zone should be modelled using separate nodes in MUSIC (i.e. a "sedimentation basin" node and a "wetland" node). When separate nodes are used, the wetland node's "Inlet Pond Volume" should be set to zero. See the figure below for an illustration.

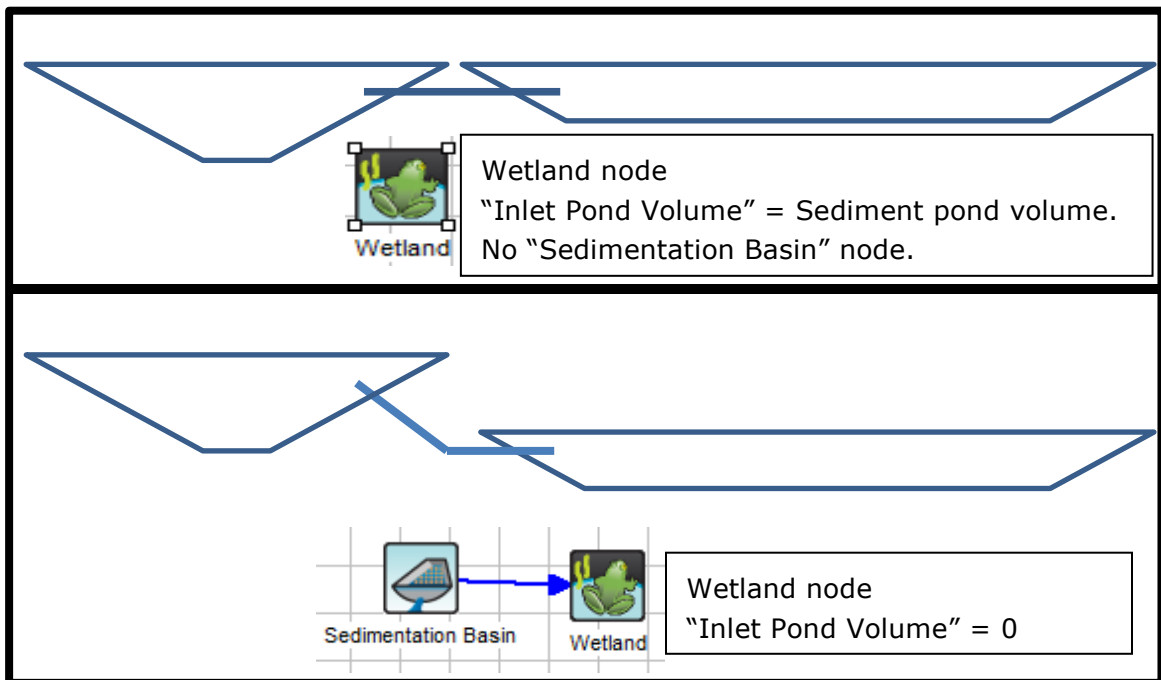

Figure 5 - Sedimentation basin and wetland node options based on relative levels of the waterbodies.

The sedimentation basin node's equivalent pipe diameter must reflect the hydraulic control between the sediment pond and macrophyte zone (this is likely to need to be defined using the custom outflow function).

The surface area and extended detention depth should match the dimensions shown on the functional design plans.

Sediment pond sizing

Calculate the modelled sediment pond volume from halfway up the sediment accumulation zone to the normal water level, as illustrated in the figure below.

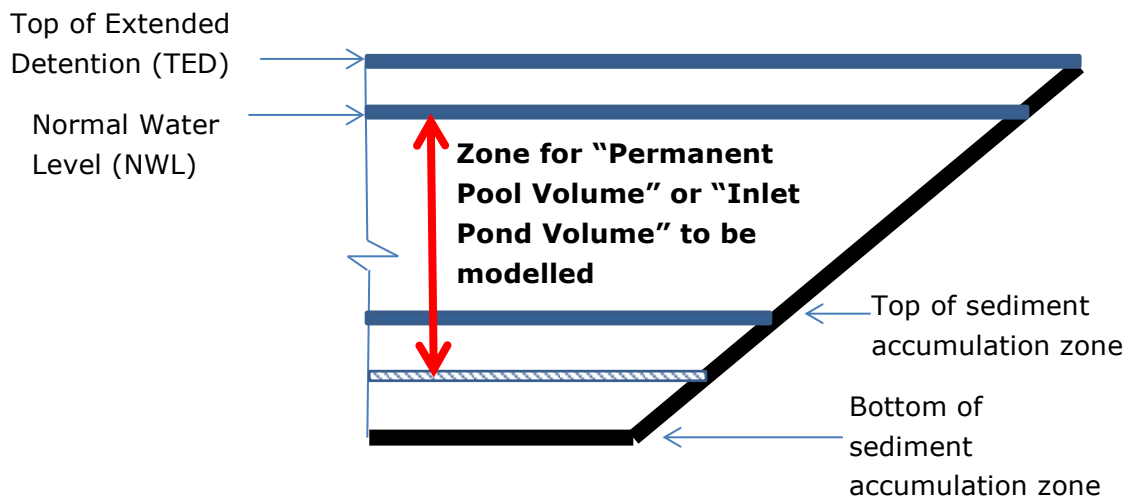

Figure 6 - Calculate the modelled sediment pond volume from halfway up the sediment accumulation zone to the normal water level

Do not design the size of the sediment pond with MUSIC alone. Sediment ponds must be designed to meet the sediment pond requirements of Melbourne Water's Constructed Wetland Design Manual. If your model results are limited by TSS requirements (rather than by TN), consult with Melbourne Water about a modelling approach.

Do not use the "Estimate Inlet Volume" / "Estimate Storage Properties" function in MUSIC.

10. Wetlands

Constructed wetland systems must be designed in accordance with Melbourne Water's Design, Construction and Establishment of Constructed Wetlands: Design Manual (Melbourne Water). This document is available from Melbourne Water's web page. MUSIC can verify the pollutant removal results of a design.

The recommendations for modelling with an inlet pond or separate sedimentation basin node are in section 9.

For Functional and Detailed Design stages, the stage storage discharge relationships of the wetland extended detention must be represented using MUSIC's Custom Outflow and Storage Relationship function. Where the wetland is within a retarding basin, the MUSIC model must also reflect the stage/storage/discharge relationship of

the retarding basin (i.e. when the water level exceeds top of extended detention (TED)).

In MUSIC the area and permanent pool volume of the wetland is entered. The permanent pool volume divided by the area must be no more than 400mm.

Wetland user defined outlet

Wetland Outlet Properties must use custom outflow and storage relationships for Functional and Detailed Designs. The following sections specify how to define custom outflow and storage.

Stage storage discharge relationship

MUSIC automatically estimates the stage-storage-discharge relationship for a wetland or pond. This is done using the permanent pool volume, surface area, extended detention depth, outlet pipe diameter and weir length.

- Stage (m) – height or depth of water in the wetland
- Storage (m³) – water storage volume for a given stage
- Discharge (m³/s) – Outflow rate (for outflow pipe or weir and for overflow pipe or weir)

It is important that the relationships are extended 2 m above the extended detention depth for the model to run, even though in reality water levels won't get that high. The default approach is adequate for concept level design, but not for functional or detailed design. Melbourne Water's Constructed Wetlands Design Manual recommends that, for functional and detailed design, the stage storage discharge relationships are defined by the user to provide greater accuracy. This is especially important for understanding the inundation frequency and duration patterns of the wetland.

MUSIC requires three relationships to be defined:

- Stage – storage
- Stage – discharge for outlet
- Stage – discharge for overflow

The height = 0 in MUSIC is normal water level. The permanent pool volume storage must be entered at the value of height = 0.

Stage – storage relationship

The stage-storage relationship describes how the water storage volume of the wetland changes as depth increases. These can be obtained from a 3D model or estimated based on the base wetland area and batter slopes.

Stage-discharge relationship

The stage-discharge relationship equation in Melbourne Water's Constructed Wetland Design Manual should be used for the outlet weir for a range of water levels.

Entering data in the Custom Outflow and Storage Properties

MUSIC by default assumes a low flow orifice outlet (Pipe Flow). In most cases, the design will have a narrow slot weir plate instead of an orifice plate. The narrow slot weir outlet properties must be defined using custom outflow properties.

MUSIC by default adds in a high flow weir outlet at the extended detention depth (Weir Flow). The discharge of the overflow (Weir Flow in MUSIC) must be set at 0 for all values equal and less than the extended detention depth level. Overflow weirs included in the design to discharge flows above the extended detention depth can be defined using the standard outflow properties box.

MUSIC by default assumes the wetland or other treatment has vertical sides. If that is not a reasonable assumption for your design it can be changed using the custom storage properties.

The figure below indicates the location of each of these input parameters within the Custom Outflow and Storage Properties when defined by the user.

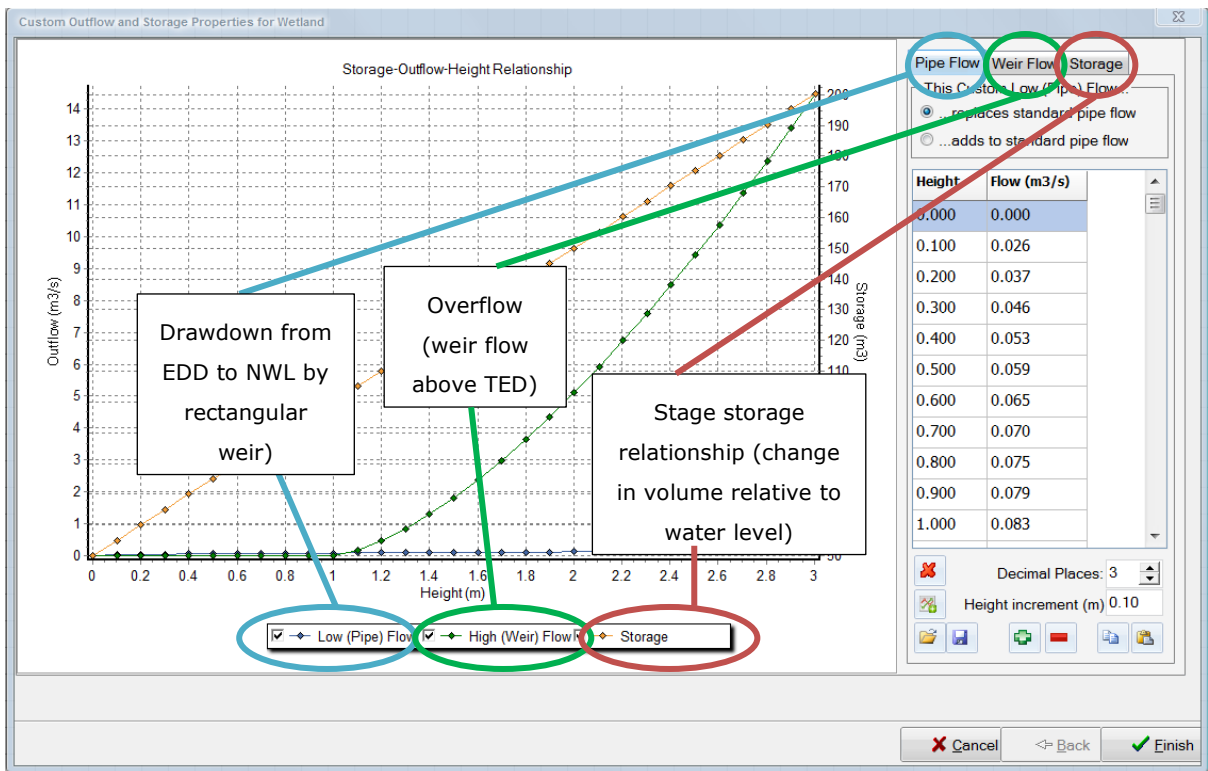

Figure 7 - Description of input parameters for Custom Outflow Storage Properties

11. Ponds

MUSIC is not a suitable model for in-lake processes, other than water balance assessments. Guidance on this topic can be found in the Melbourne Water publication "[Constructed Shallow Lake Systems for Developers](#)". This document is available as a PDF download from Melbourne Water's web page. Ponds will not be accepted as treatment nodes.

12. Bioretention systems (raingardens, biofilters)

Standard bioretention systems are not suited to take runoff from catchments larger than 10 hectares (Australian Rainfall & Runoff, Book 9, Section 4.5.4). Designs with bioretention nodes treating catchments greater than 10 hectares will not be accepted.

Sediment removal

Bioretention systems with catchments greater than 5 Ha should have a sediment pond upstream. Bioretention systems with catchments less than 5 Ha should have a vegetated swale, coarse sediment forebay, inlet pond or gross pollutant trap on the inlet.

Filter media

In the model, the hydraulic conductivity of the filter media should match the specification or be a conservatively lower figure (as recommended in the [Adoption Guidelines for Stormwater Biofiltration Systems 2015](#)). An acceptable range for the hydraulic conductivity of a bioretention system is 100mm/hr – 300mm/hr.

Submerged zones, or systems without an underdrain, are generally recommended if site conditions permit. If a submerged zone is not used, the filter media depth field in MUSIC must not include the transition or drainage layers. Drainage and transition layers can be included as part of the submerged zone depth.

Plant species selection

The [Adoption Guidelines for Stormwater Biofiltration Systems 2015](#) recommend some specific plant species as well as recommending typical characteristics of plants that provide effective nutrient removal. If effective nutrient removal plants are selected under 'Vegetation Properties' (recommended), the planting specification must support this.

The design must provide adequate soil moisture to sustain plants. This can be achieved through:

- minimum filter media depth of 400mm (500mm preferred),
- a submerged zone
- no underdrain
- appropriate size treatment area relative to the catchment (generally 50-100 times the area of the bioretention system)
- a reliable source of irrigation.

Extended detention depth

Consideration should be given to the extended detention depth selected for bioretention systems. The depth should be safe for construction, operation and maintenance of the system. If the system has a longitudinal slope, it will not have a uniform extended detention depth, and therefore an average should be selected.

13. Permeable pavement

Permeable pavement should be modelled as per the manufacturer's guidelines. Documentation supporting the modelling must be submitted for review.

14. Imported data nodes

Supporting documentation will be required to demonstrate the use of any imported data nodes in models.

15. Generic treatment nodes

Melbourne Water will publish a list of, if we accept any, products that can be modelled as generic treatment nodes with pollutant removal. There are currently no products that we will accept treatment from through generic nodes.

A generic treatment node may be used to simulate a pump, by setting the flow rate passing through the node to the maximum pump flow rate. Flows in excess of the pump flow rate may need to be accounted for using a duplicate catchment.

Generic nodes may be used to simulate the splitting of flows, where a flow rate based diversion is used. Appropriate documentation and calculations must be provided to justify the split of flows, if used to simulate splitting flows. Most flow splits can be more easily modelled using a secondary link to split flows from a catchment or treatment outlet.

For generic nodes, within a transfer curve, the outflows, or pollutant concentrations out, must not exceed the inflows, or pollutant concentrations in. A pollutant balance should be done to check that pollutants are not created or lost, as generic treatment node outputs can easily be misinterpreted.

16. Use of secondary links

Secondary links can be used to direct surface flows and baseflows through different routes. For example, surface flows may be directed through treatment systems while baseflows pass through groundwater and discharge directly into the receiving water. This can be modelled by adding a secondary link to a catchment and routing it around the treatment to the receiving node.

Secondary links are particularly useful for controlling outflows from treatment nodes. For example, they can be used to model piped flows from a treatment system entering a downstream treatment while overflows or bypass flows are routed around it. This is especially useful when modelling stormwater reuse systems where only treated flows are likely to be captured for reuse, while overflows are likely to bypass the reuse system.

Another scenario where secondary links are particularly useful is when directing pumped flows from one treatment to another treatment/storage from which reuse is extracted.

Treatment nodes should only have baseflows bypassing from source nodes that have significant areas of unmodified natural environments.

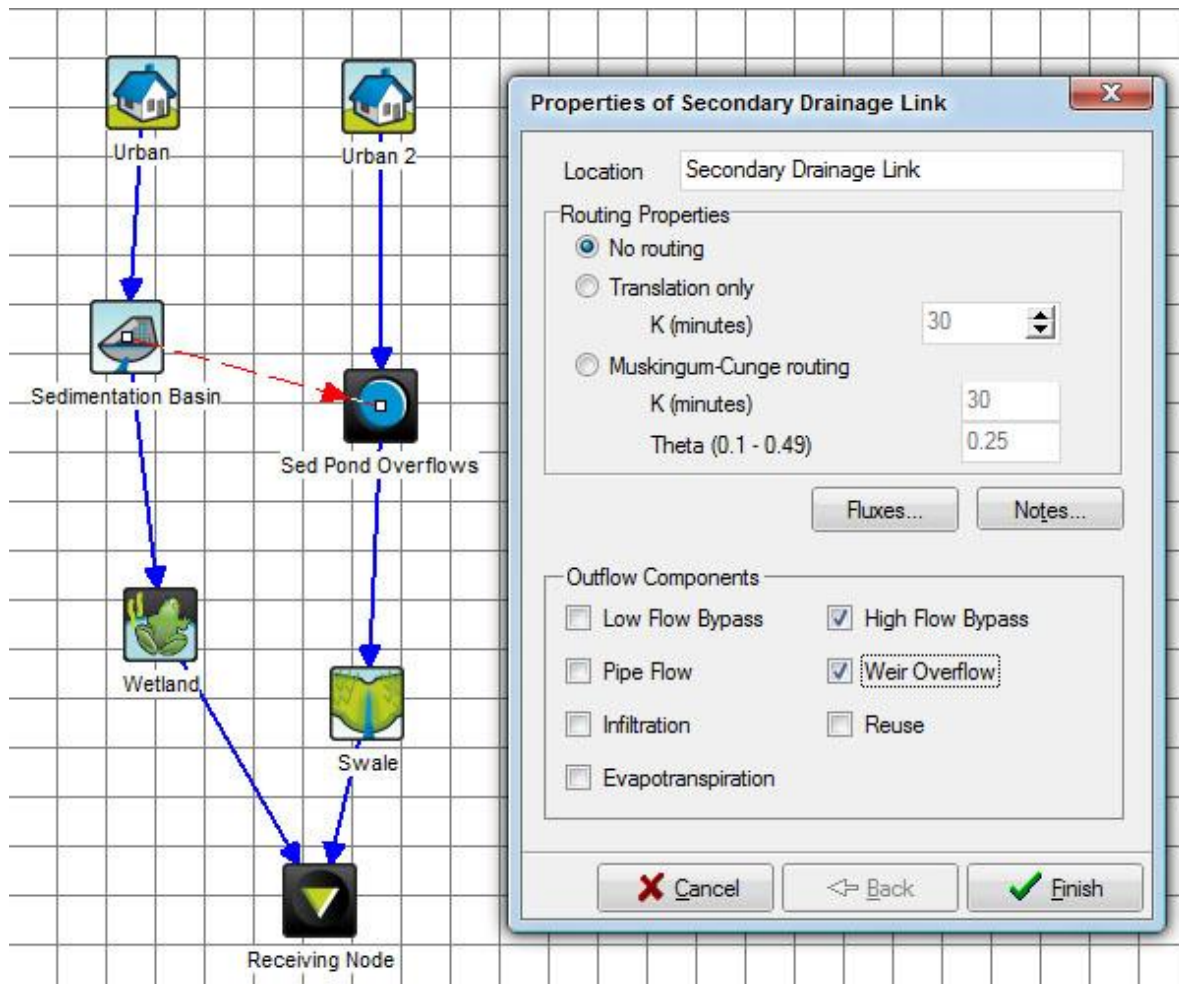

Figure 8 - A MUSIC model containing a secondary link

It is important when using secondary links to ensure that all flows are directed back into the final receiving node before reporting to ensure flows are not lost.

17. Exporting results

An inundation frequency curve illustrates the frequency with which certain depths are exceeded within a treatment system such as a wetland.

To undertake a frequency analysis, the treatment system depth data must be exported from MUSIC using the 'flux file'. Recent versions of MUSIC can export the data at a daily timestep that is easier to handle.

How to create a flux file

1. Right click on wetland and select 'Edit properties'

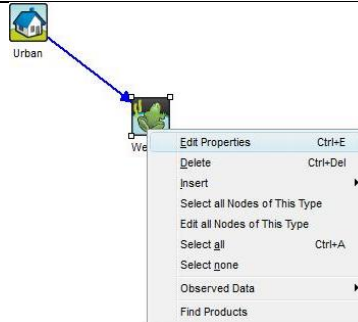

2. Click on 'Fluxes'

Properties of Wetland

Location: Wetland

Inlet Properties

Low Flow By-pass (cubic metres per sec)	0.000
High Flow By-pass (cubic metres per sec)	100.000
Inlet Pond Volume (cubic metres)	0.0

Estimate Inlet Volume

Storage Properties

Surface Area (square metres)	50.0
Extended Detention Depth (metres)	1.00
Permanent Pool Volume (cubic metres)	50.0
Initial Volume (cubic metres)	50.00
Vegetation Cover (% of surface area)	50.0
Exfiltration Rate (mm/hr)	0.00
Evaporative Loss as % of PET	125.00

Outlet Properties

Equivalent Pipe Diameter (mm)	200
Overflow Weir Width (metres)	3.0
Notional Detention Time (hrs)	0.149

Use Custom Outflow and Storage Relationship

Define Custom Outflow and Storage Not Defined

Re-use... Fluxes... Notes... More

Cancel Back Finish

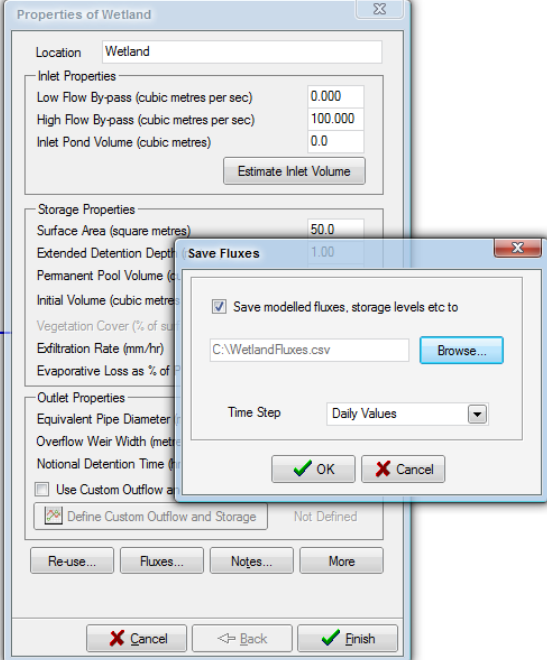
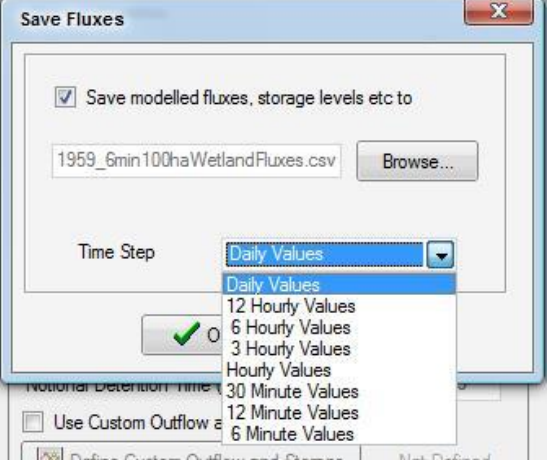
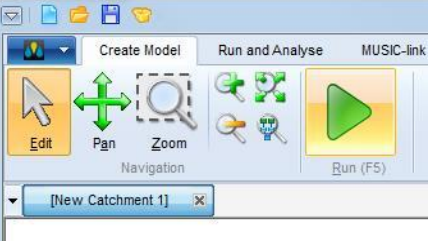
<p>3. Tick 'Save modelled fluxes' and set a filename.</p>	
<p>4. Change the Timestep to 'Daily' (Very important)</p>	
<p>5. Run the MUSIC model</p>	

Once the flux file is created, an inundation frequency curve can be created automatically from a daily flux file using the Wetland Analysis Tool (on www.MUSICauditor.com.au) or manually in a spreadsheet following the guidance provided in the [Constructed Wetlands Design Manual Part D](#).

Assessing flow rates for the 1.5 year ARI

The BPEM flows objective, or other flow objectives based on stream erosion potential, can be assessed in MUSIC. To make sure the 1.5 year flow rate in MUSIC is sensible, compare the partial series from the MUSIC model (without any treatment/retardation) with peak 1 to 2 year flow estimates from an appropriate method (see Australian Rainfall and Runoff). Options for modelling are:

- a) Manually create a rainfall file to use in MUSIC that contains a range of 1.5 year peak rainfall events (i.e. for a range of storm durations) and then run it through the MUSIC model and compare the maximum outflow rate with the pre development 1.5 year flow rate. This approach doesn't take into account antecedent conditions in storages (i.e. how full they are at the start of the event). A worst case scenario is rainwater tanks and extended detention storages are full at the start of the 1.5 year event.
- b) Use 10 years of historical rainfall data. Open a flow timeseries plot for the downstream end of the developed catchment. Identify the flow rate of the 7th highest flow event (which should be the post development 1.5 year flow based on partial series plotting position) and compare to the pre-development peak 1.5 year flow rate.

18. Submission requirements for MUSIC modelling

Constructed wetlands

Melbourne Water's submission requirements for constructed wetlands are in Part B of the [Constructed Wetlands Design Manual](#). An excerpt of the submission requirements that directly relate to MUSIC modelling are provided below.

Wetland concept design

1. Summary of MUSIC modelling (or alternative method or models), including:
 - a) version of MUSIC
 - b) meteorological data used
 - c) map outlining catchment areas and direction of flows
 - d) justification for choice of source node impervious percentage
 - e) any routing used
 - f) treatment node parameters
 - g) any modelling parameters that are not in accordance with Melbourne Water's MUSIC Modelling Guidelines (this document)
 - h) pollutant removal results
2. A copy of the MUSIC model
3. Drawings of the treatment system, including placements, which match the model.

Wetland functional design

1. A description of the updated MUSIC model (or alternative method or models), including matching:
 - a) the inlet pond volume in MUSIC to the sediment pond volume shown on plans (from halfway up the sediment accumulation zone)
 - b) the permanent pool volume to the proposed bathymetry (using the user defined stage-storage relationship)
 - c) the high flow bypass configuration to the design
 - d) the extended detention controlled outlet configuration to the design (using the user defined stage-storage relationship)
2. An [inundation frequency analysis](#) of water levels in the macrophyte zone
3. The [90th percentile residence time](#) in the macrophyte zone
4. A report from [MUSIC auditor tool](#)
5. Drawings of the treatment system, including placements, which match the model.

Other treatment devices

In general, the functional design report should incorporate the following information for systems (other than wetlands) modelled in MUSIC:

1. Description of the function and intent of the treatment system.
2. Description of how fraction impervious was calculated (what figures were used for different zonings).
3. Drawings of the treatment system, including placements, which match the model.
4. Specification for the treatment system, including any soil or filter media.
5. Vegetation specification for bioretention systems.
6. Description of any updates to the MUSIC model at each stage of the design.
7. Summary of MUSIC modelling (or alternative method or models), including:
 - a) version of MUSIC
 - b) meteorological data used
 - c) catchment areas with impervious percentage
 - d) any routing used
 - e) treatment node parameters
 - f) any modelling parameters that are not in accordance with Melbourne Water's MUSIC Modelling Guidelines
 - g) A copy of the MUSIC model
 - h) A report from [MUSIC auditor tool](#)